

单位 Units: mm
1 inch=25.4mm

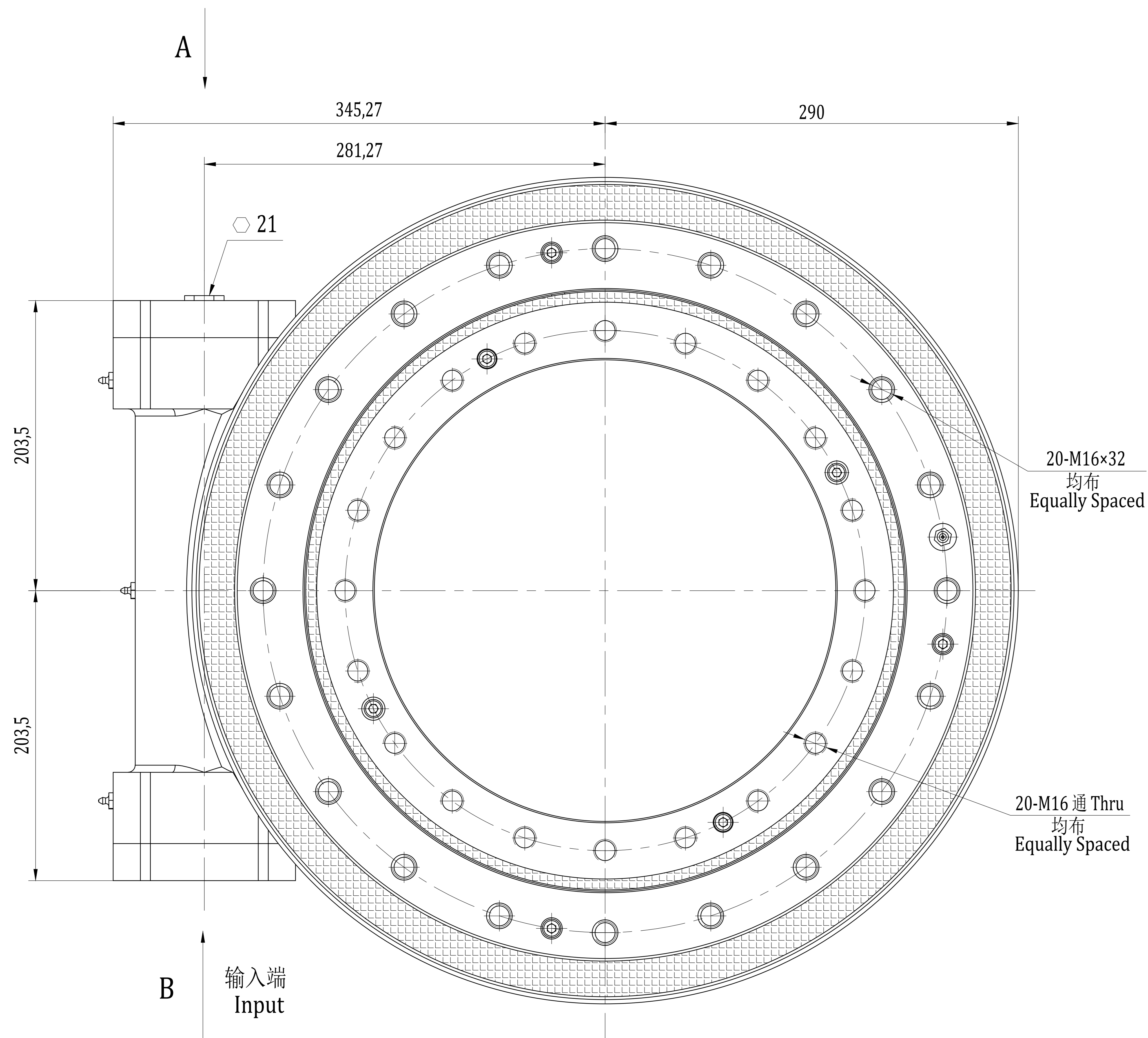

A向/A View

带六角头
With Hex

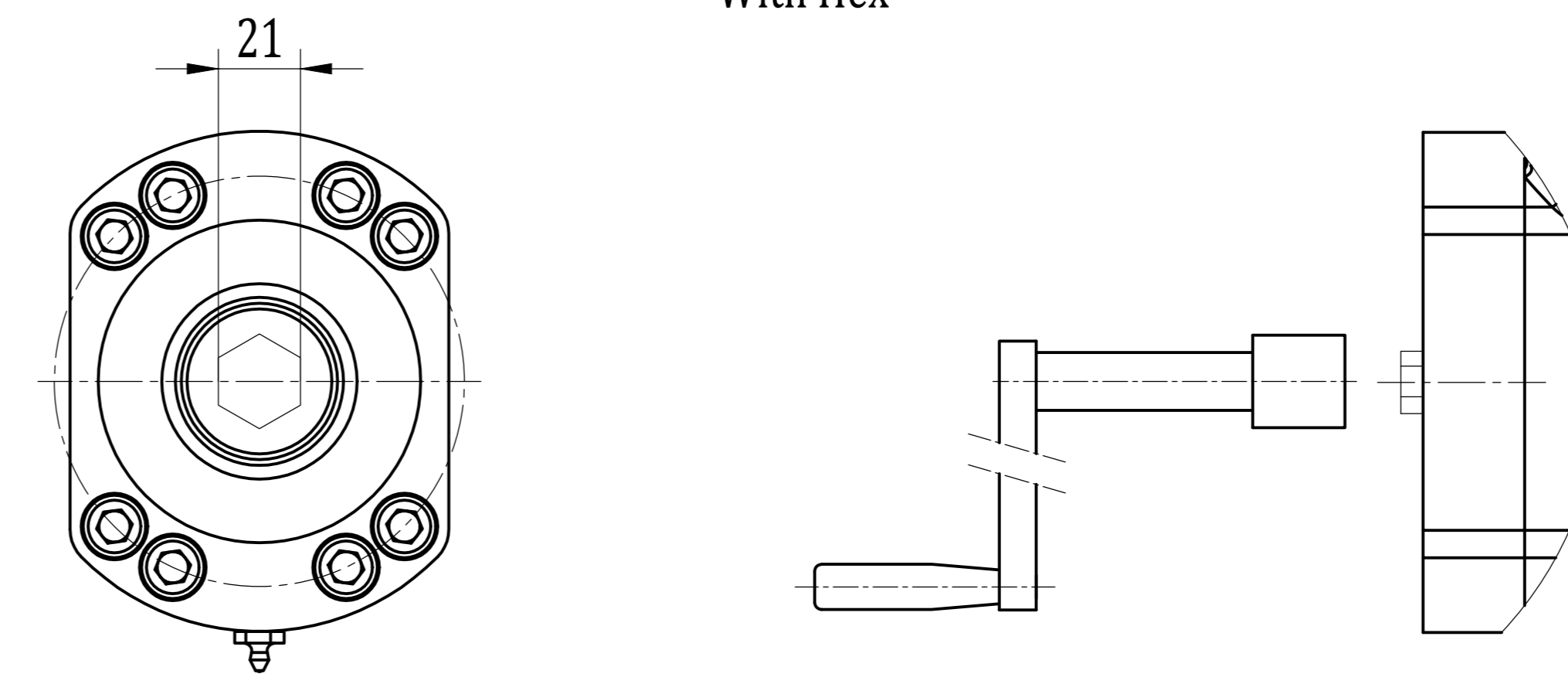

B向/B View

输入端 Input
Ø25孔 (Ø25 Hole)

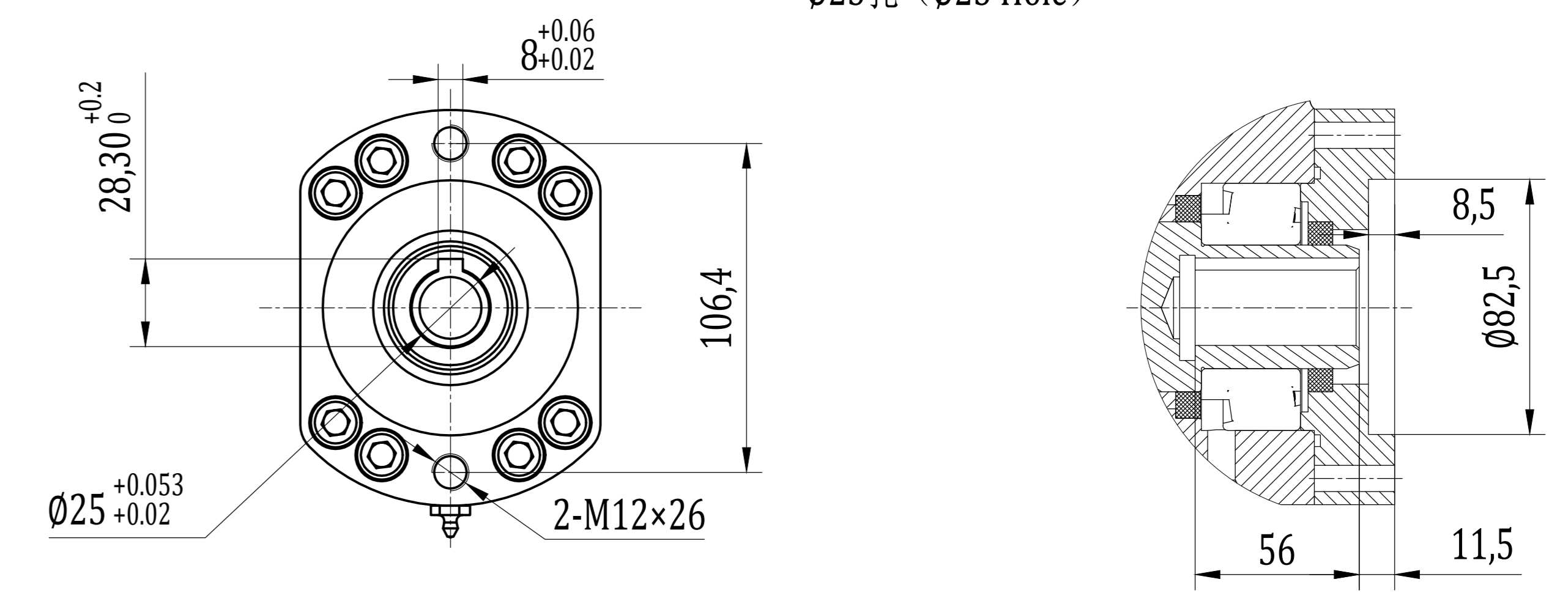

输入端 Input
6B花键 (6B Spline)

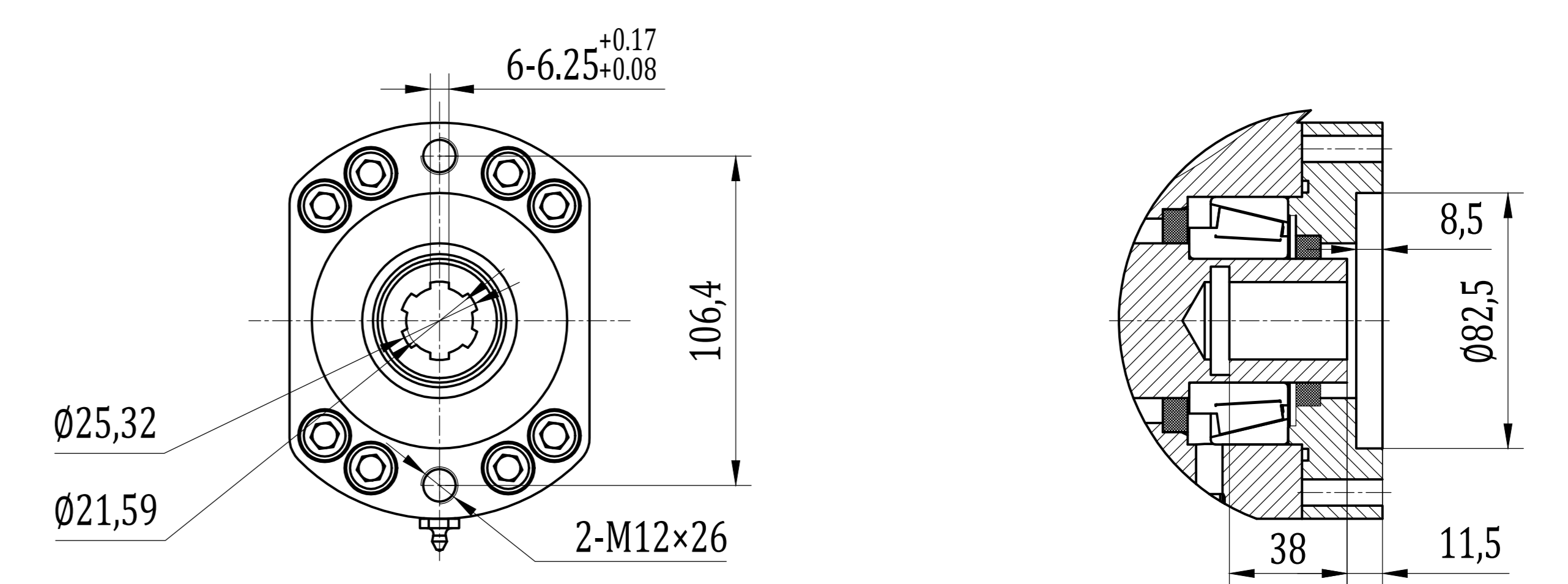

98 kg

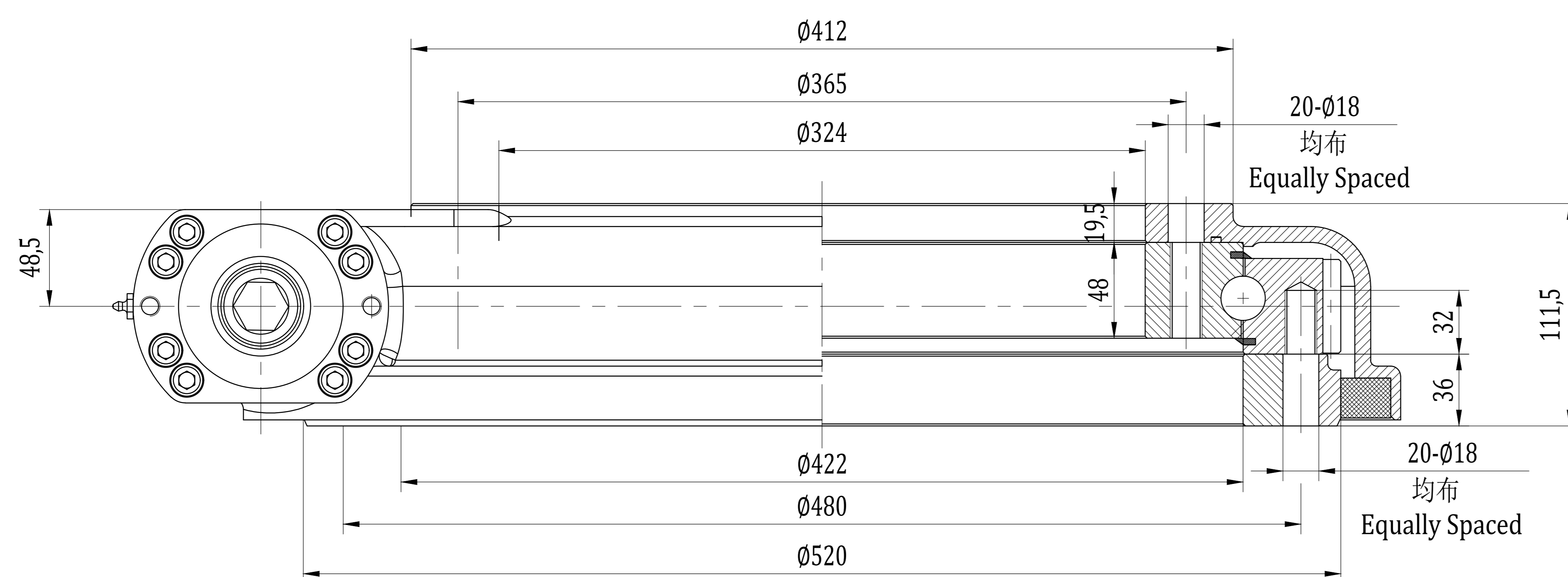

SC17

回转驱动 Slewing Drive